

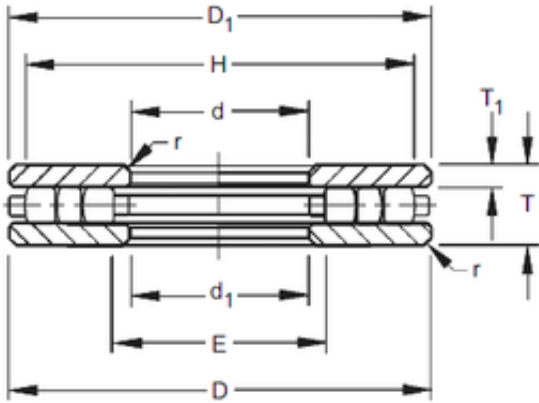

Timken 40TP114 Thrust Cylindrical Roller Bearing

Bearing No. 40TP114



40TP114 Bearing 2D drawings and 3D CAD models

Size	101.6x177.8x44.45 mm
Bore Diameter	101,6 mm
Outer Diameter	177,8 mm
Width	44,45 mm
d	101,6 mm
D	177,8 mm
T	44,45 mm
r max	1,6 mm
T1	12,7 mm
d1	103,19 mm
D1	176,21 mm
E	111,1 mm
H	168,3 mm