

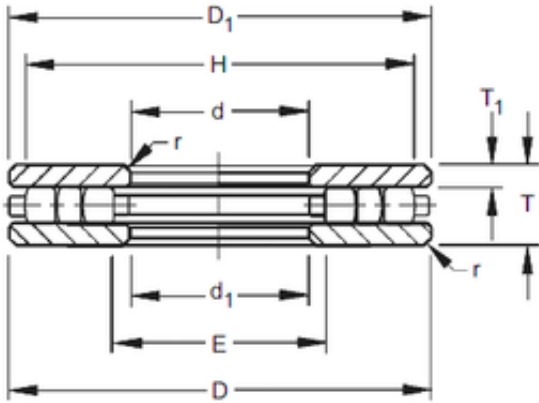

Timken 40TP115 Thrust Cylindrical Roller Bearing

Bearing No. 40TP115



40TP115 Bearing 2D drawings and 3D CAD models

Size	101.6x203.2x44.45 mm
Bore Diameter	101,6 mm
Outer Diameter	203,2 mm
Width	44,45 mm
d	101,6 mm
D	203,2 mm
T	44,45 mm
r max	1,6 mm
T1	12,7 mm
d1	103,19 mm
D1	201,61 mm
E	114,3 mm
H	190,5 mm