

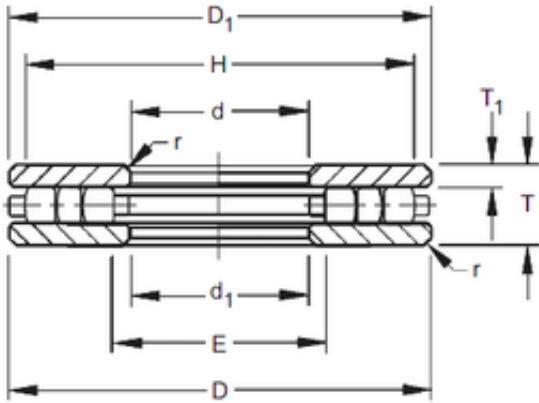

Timken 70TP130 Thrust Cylindrical Roller Bearing

Bearing No. 70TP130



70TP130 Bearing 2D drawings and 3D CAD models

Size	177.8x279.4x50.8 mm
Bore Diameter	177,8 mm
Outer Diameter	279,4 mm
Width	50,8 mm
d	177,8 mm
D	279,4 mm
T	50,8 mm
r max	3,2 mm
T1	14,29 mm
d1	180,18 mm
D1	277,02 mm
E	190,5 mm
H	266,7 mm