

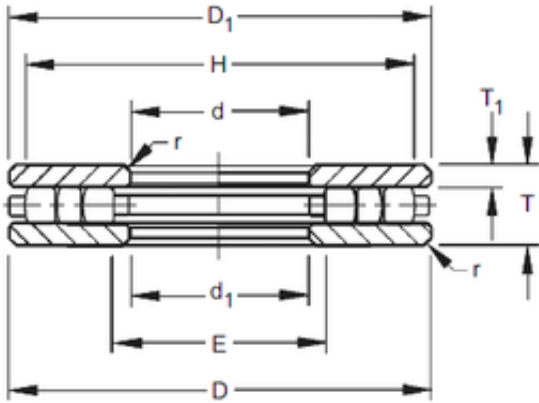

Timken 240TP177 Thrust Cylindrical Roller Bearing

Bearing No. 240TP177



240TP177 Bearing 2D drawings and 3D CAD models

Size	609.6x812.8x139.7 mm
Bore Diameter	609,6 mm
Outer Diameter	812,8 mm
Width	139,7 mm
d	609,6 mm
D	812,8 mm
T	139,7 mm
r max	9,5 mm
T1	38,1 mm
d1	612,8 mm
D1	809,6 mm
E	631,8 mm
H	790,6 mm