

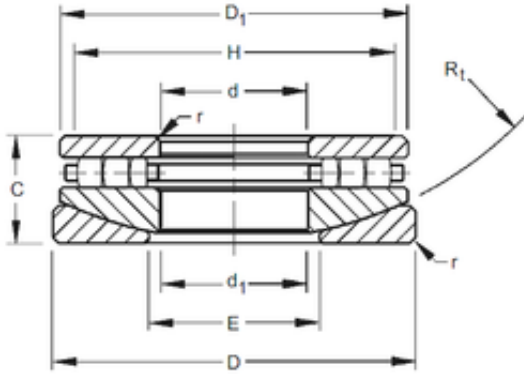

Timken 30TPS106 Thrust Cylindrical Roller Bearing



Bearing No. 30TPS106

Bore Diameter	76,2 mm
Outer Diameter	160,325 mm
d	76,2 mm
D	160,325 mm
r max	1,6 mm
d1	77,79 mm
C	46,038 mm
D1	150,81 mm
E	101,6 mm
H	142,9 mm
R	152,4 mm

30TPS106 Bearing 2D drawings and 3D CAD models