

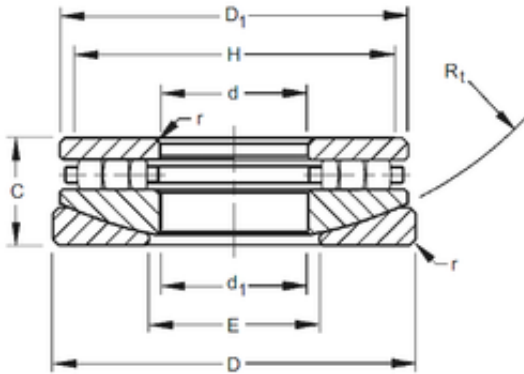

Timken 50TPS123 Thrust Cylindrical Roller Bearing



Bearing No. 50TPS123

Bore Diameter	127 mm
Outer Diameter	317,5 mm
d	127 mm
D	317,5 mm
r max	3,2 mm
d1	130,18 mm
C	66,675 mm
D1	303,21 mm
E	184,1 mm
H	288,9 mm
R	501,65 mm

50TPS123 Bearing 2D drawings and 3D CAD models