

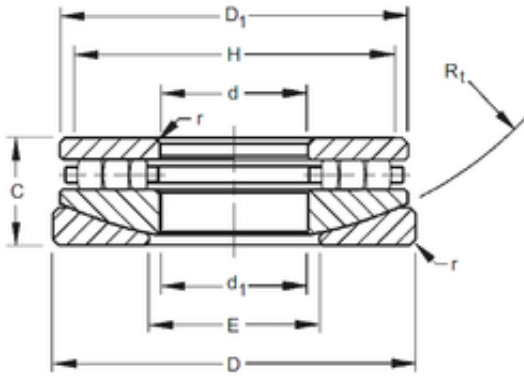

Timken 140TPS158 Thrust Cylindrical Roller Bearing



Bearing No. 140TPS158

Bore Diameter	355,6 mm
Outer Diameter	530,225 mm
d	355,6 mm
D	530,225 mm
r max	6,4 mm
d1	361,95 mm
C	123,825 mm
D1	504,82 mm
E	393,7 mm
H	489 mm
R	495,3 mm

140TPS158 Bearing 2D drawings and 3D CAD models